



**Barcelona
Supercomputing
Center**

Centro Nacional de Supercomputación



EC-Earth land surface model : development of the offline configuration and application to decadal prediction of wildfires

**Etienne Tourigny, Raffaele Bernardello
Valentina Sicardi, Mario Acosta, Emanuel Dutra
Lund University partners**



The 2017 fire season in California WAS the costliest on record, with 18 Billion US\$ in damages, and deadliest with 43 casualties on record.

2018 wildfire season was even worse...





In October, around the Napa valley in Northern California, the Tubbs fire was the most destructive in US history. Warm temperatures and strong winds are thought to be responsible for the severity of these wildfires.



In December, Southern California was plagued by severe wildfires and the Thomas fire near Los Angeles became the largest in California history. It was thought to be fueled by severe Santa Ana winds and warmer than average temperatures.



In June 2017, the infamous “Pedrogão Grande” wildfires (in central Portugal) killed 62 people trapped in their cars as they fled the intense wildfires.



In October 2017, wildfires raged across northern Portugal and Galicia (Spain). The wildfires were made possible due to an intense drought and fueled by intense winds from Hurricane Ophelia. Arson is believed to be responsible for igniting many fires.

- Seasonal Prediction of Fire danger using Statistical and Dynamical models (SPFireSD) is a MARIE Skłodowska-CURIE ACTIONS Individual Fellowship (MSCA-IF)
- SPFireSD proposes to develop and assess seasonal fire prediction capability through a variety of complementary and innovative methods using statistical and dynamical models, with a focus on Europe, the Amazonian basin and Indonesia.
- This project will develop and assess seasonal prediction capability of wildfire danger using three complementary approaches:
 - 1) **Fire danger indices approach**: simple fire danger indices computed from seasonal dynamical climate prediction systems
 - 2) **Statistical approach**: statistical fire danger models using a combination of past observational data and seasonal dynamical climate forecasts
 - 3) **Dynamical approach: ensemble dynamical predictions** using state-of-the-art fire models within Earth System Models (LPJ-Guess part of the EC-Earth Earth System Model)

Fire modeling across scales

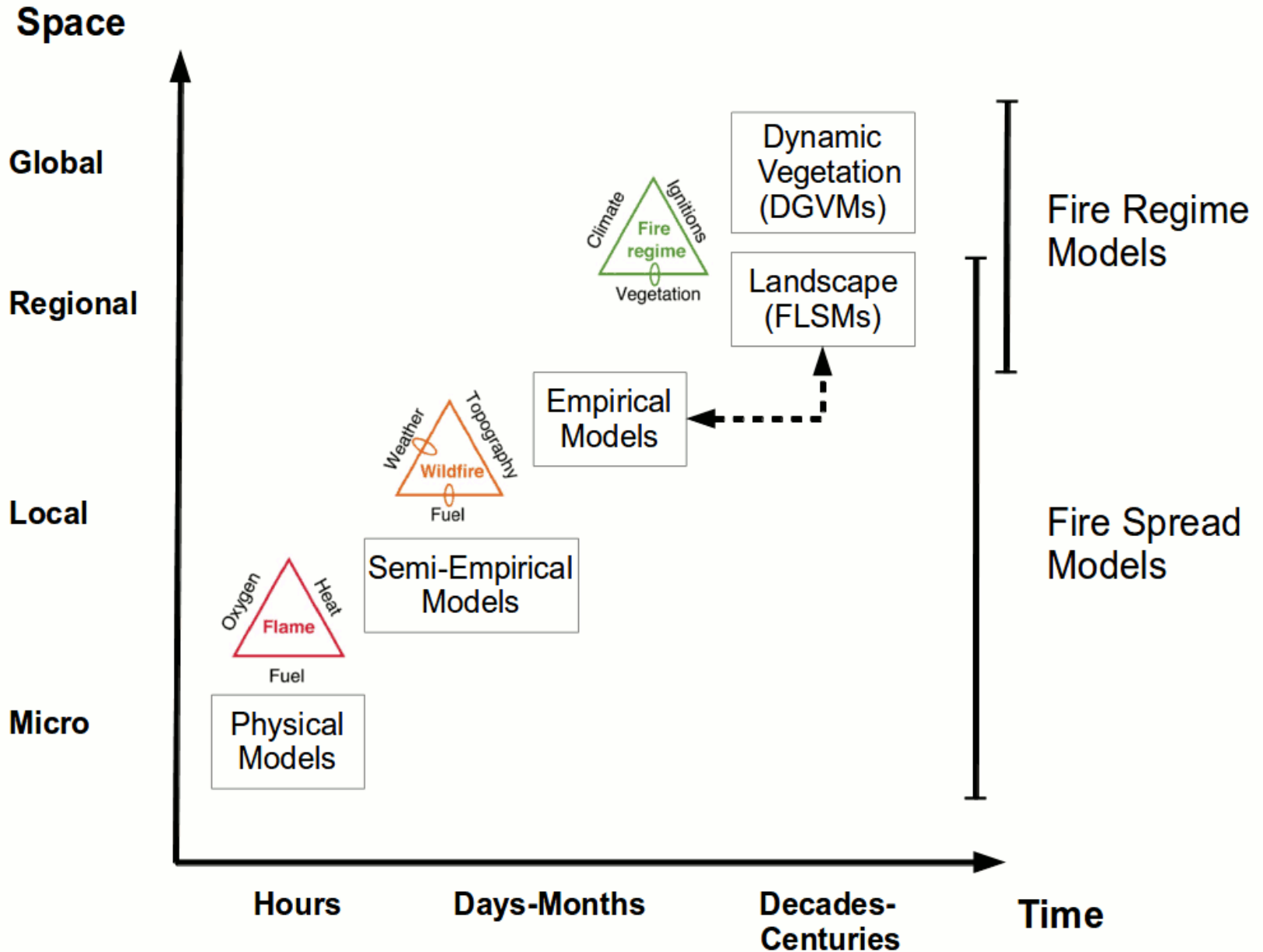

a)

Schematics of the land surface

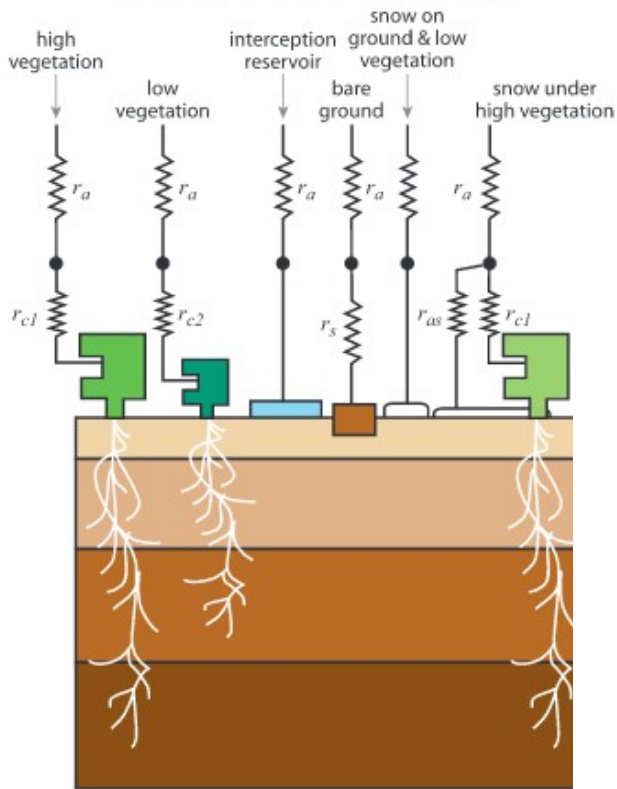

LPJ-GUESS: A modular, individual-based process-oriented ecosystem model*

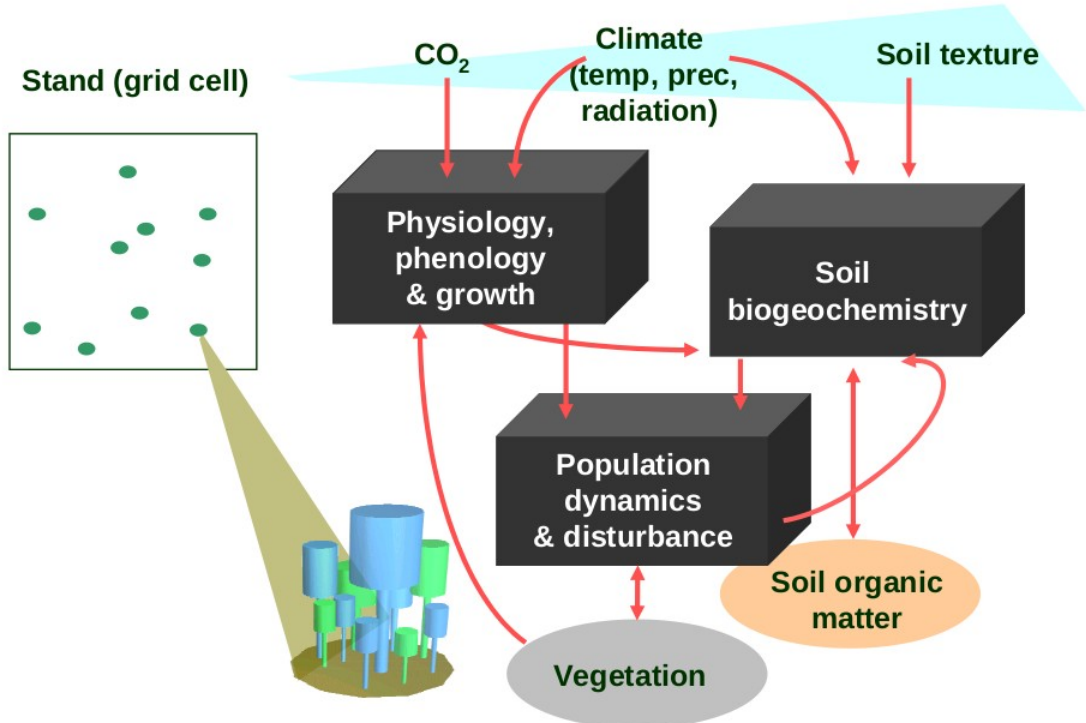

*Smith et al. 2001 *Global Ecology and Biogeography* 10: 621

LSM (Land Surface Model) contains 3 components:

LPJG, as used in the ESM configuration

LPJG-forcing (aka Sparring), used to send atmospheric forcings to LPJG

OSM (Offline Surface Model), offline version of the IFS land surface model (H-TESSSEL)

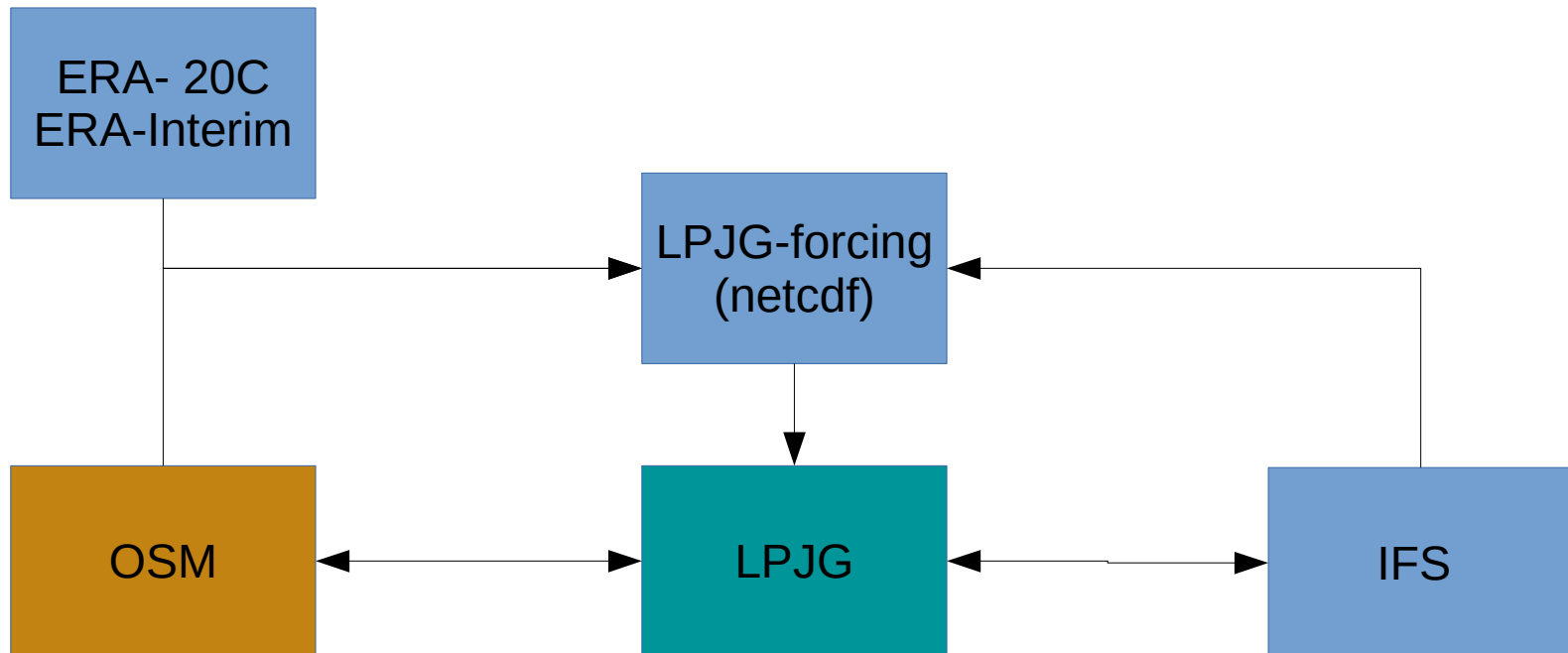

```
# -----  
# *** General configuration  
# -----  
# Component configuration (for syntax of the $config variable, see libruncscript.sh)  
#  
# Currently maintained:  
#   config="osm"           # OSM (Offline Surface Model, H-TESSSEL forced by  
IFS output)  
#   config="lpjg lpjg_forcing:IFS" # LPJG-Offline forced by IFS/OSM output  
#   config="lpjg osm"      # LPJG & OSM Coupled via OASIS  
#                           # In this config lpjg can take the option:  
#                           # lpjg:fdbck to feedback on the OSM  
  
config="lpjg:fdbck osm"  
  
# minimum sanity  
has_config ifs && error "Cannot have ifs in config"  
has_config nemo && error "Cannot have nemo in config"  
has_config lpjg_forcing osm && error "Cannot have both lpjg_forcing and osm in config"  
  
# libosm defines some OSM and LPJG pre/post-processing functions  
has_config any osm lpjg_forcing && source ./libosm.sh
```

- WHY?
 - Easy tool for quick testing & validation
 - Requirements for CMIP6 (LUMIP, LS3MIP, etc.) & other projects
 - Development of new codes quick & easy
- History:
 - ??? Uwe, Paul Miller develop the Sparring, which simulates the IFS by sending and receiving data to LPJG via OASIS calls, Klaus develops script to convert IFS output to daily netcdf files
 - July 2017 – Dec 2017 : development of the initial ece-lsm.sh script by Etienne, with help from Paul, Lars & Peter Anthoni, merged into the initial ESM branch (issue #412)
 - Nov. 2017 – Jan 2018 : Development of the OSM by Emanuel Dutra “off-line HTESSEL model downgraded from openIFS (cy43r1)” (issues #380 #458)
 - July 2018 – Nov. 2018 : coupling htessel and lpjg by Emanuel Dutra (issue #572)
 - Nov. 2018 – today : bugfixes and optimizations, synced with 3.3.1 by Etienne, multiple resolution support (issues #555, #596)
 - Very soon in trunk

OSM validation – using IFS output

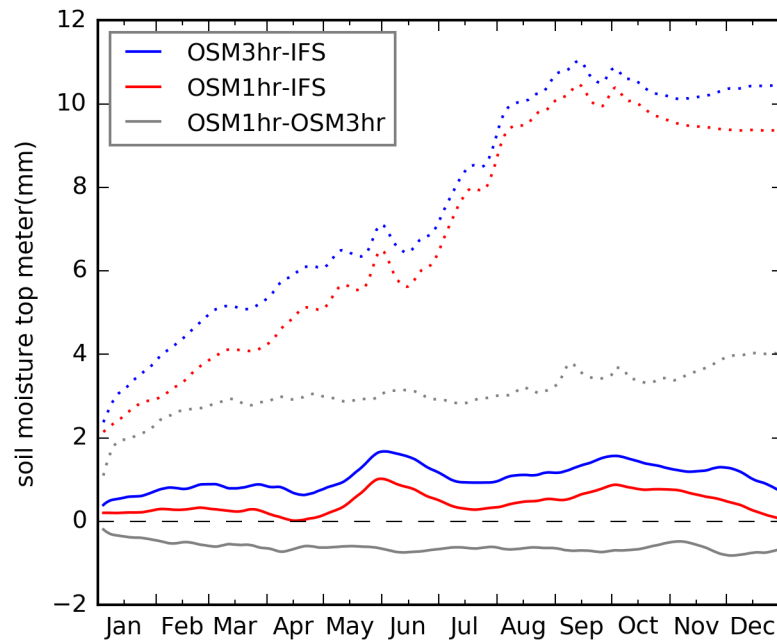
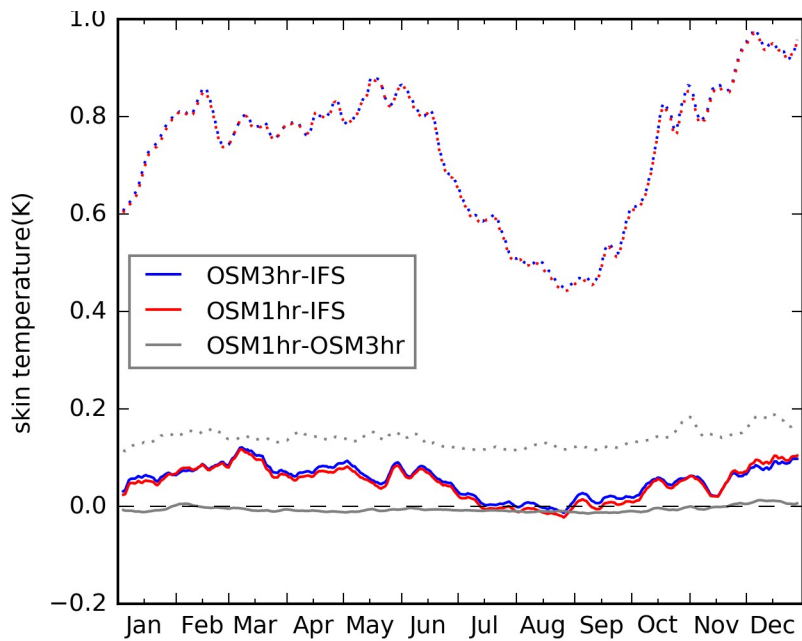
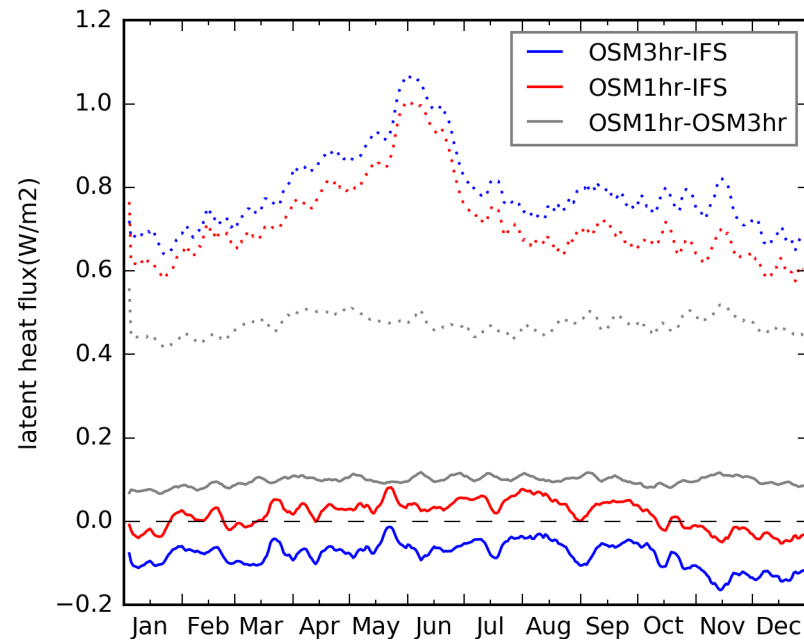
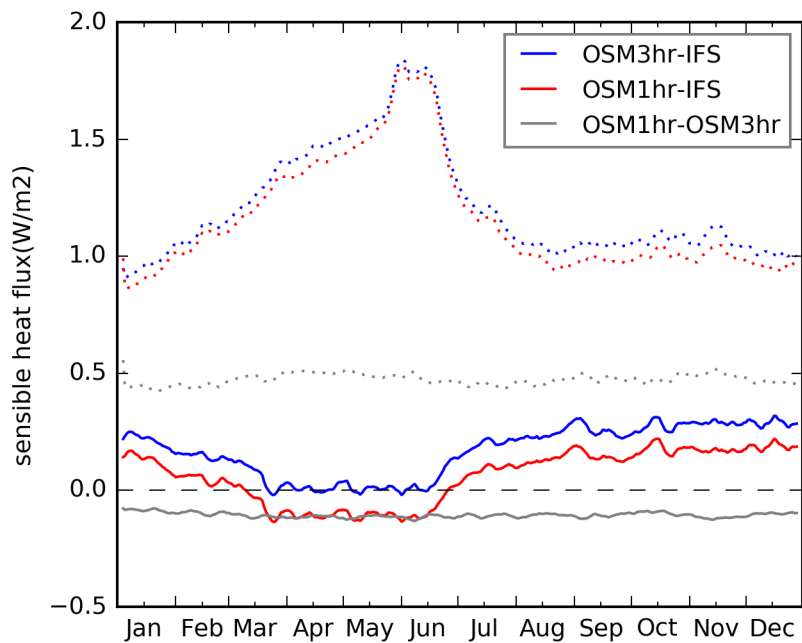

- Performance (on Marenostrum4):
 - LPJG only:
 - 30 minutes/year initially
 - 7 minutes/year after I/O opt + compressed output
 - OSM only: 10 minutes/year
 - LPJG + OSM : 15 minutes/year
- The Future of LSM development
 - Pending merge into trunk: LPJG vendor drop for compressed output, correct bug found in OSM → LPJG
 - scientific validation & testing by others
 - Integration of LS3MIP changes into surf/offline
 - Use in CMIP6 : LS3MIP, LUMIP & DCPP/CCiCC

Climate prediction experiments

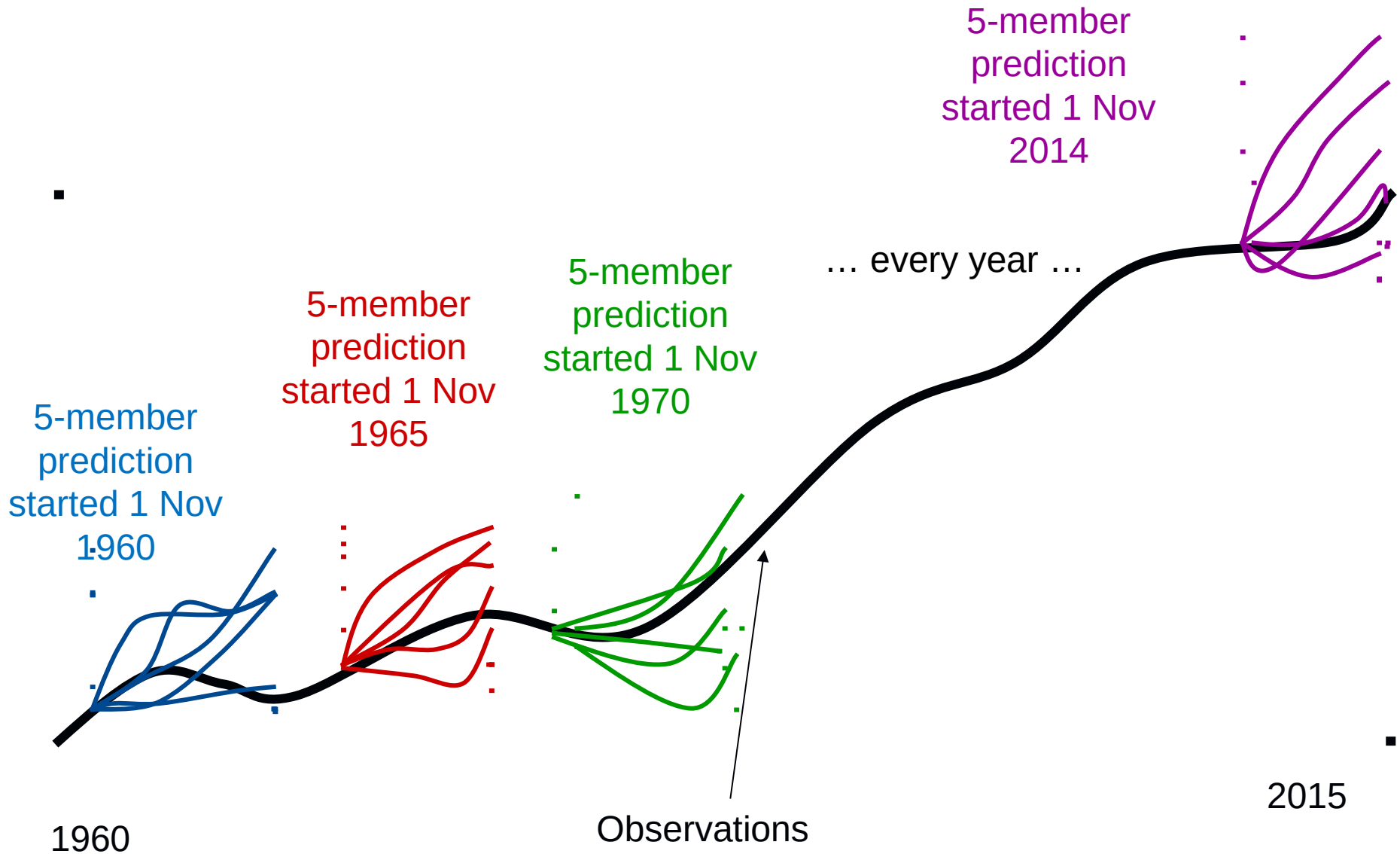

- DCPP LPJG-offline experiment :
 - LPJG initial states from Klaus' t613 run (EC_Earth-Veg)
 - Daily output from BSC's DCPP hindcasts (1960-2015), 5 years, 5 members
 - Allows to test the fire model before doing fully-coupled decadal hindcasts of the carbon cycle (CCiCC)

Global Mean SST (1st Year)

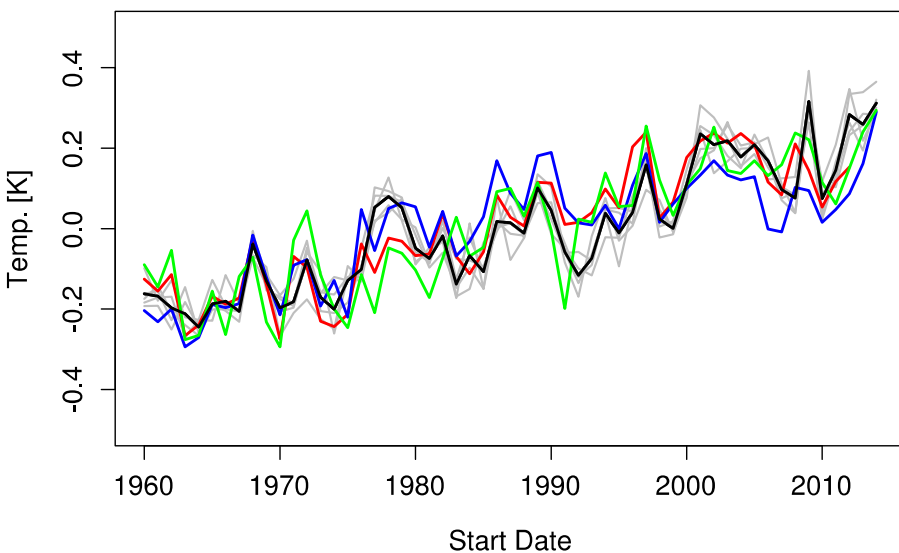

ACC Global Mean SST

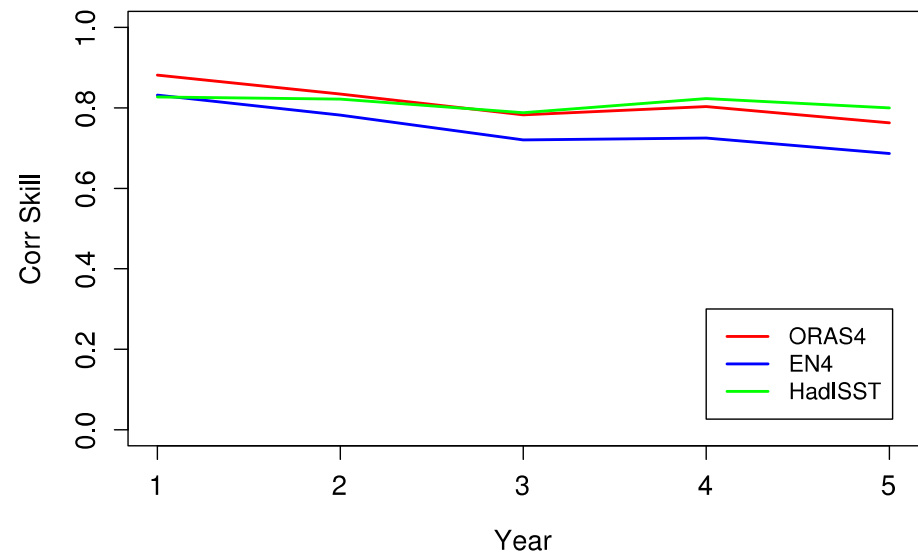

- DCPP LPJG-offline experiment (a1wj):
 - LPJG states from Klaus' t613 run (EC_Earth-Veg)
 - Daily output from BSC's DCPP hindcasts (1960-2015), 5 years, 5 members
 - 1 hour to run 5 years on 2 nodes
 - 1 hour to CMORize on 1 node!!!

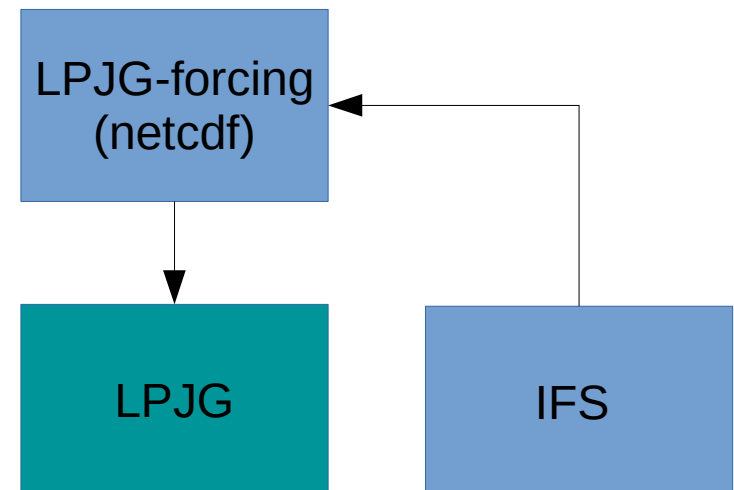

Climate prediction experiments



UNKNOWN

WAITING

READY

SUBMITTED

QUEUING

RUNNING

COMPLETED

FAILED

SUSPENDED

+

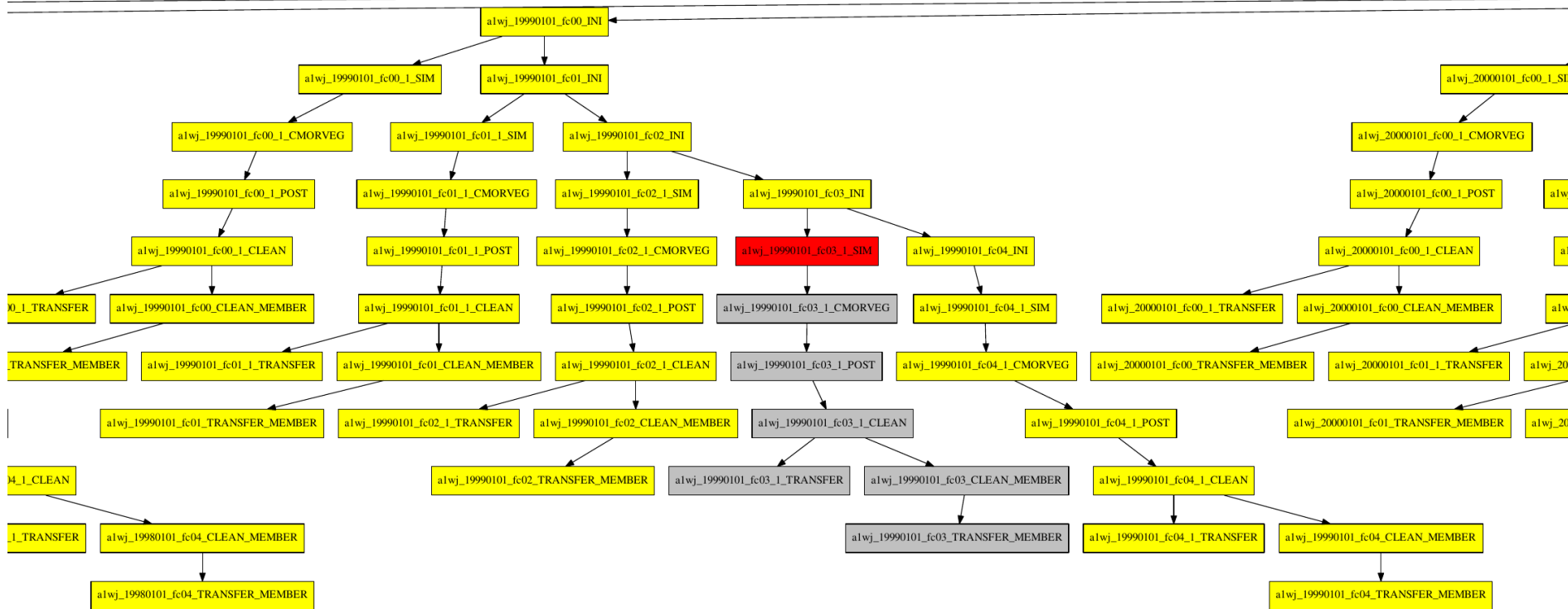

cVeg - C in vegetation

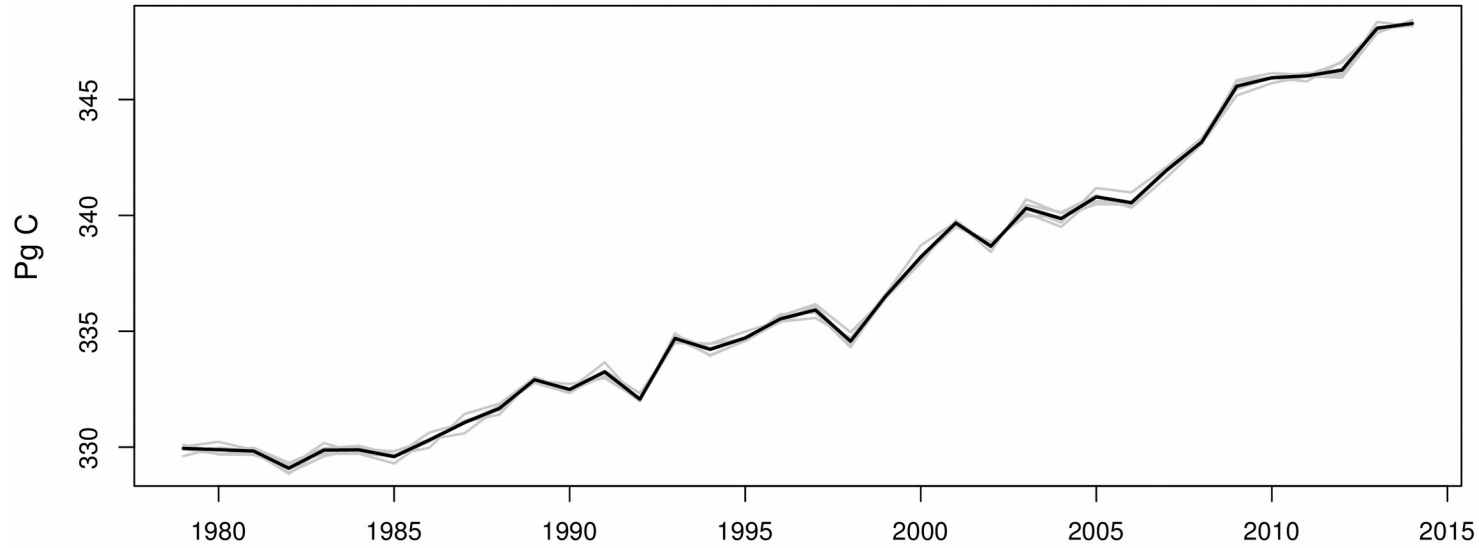

npp

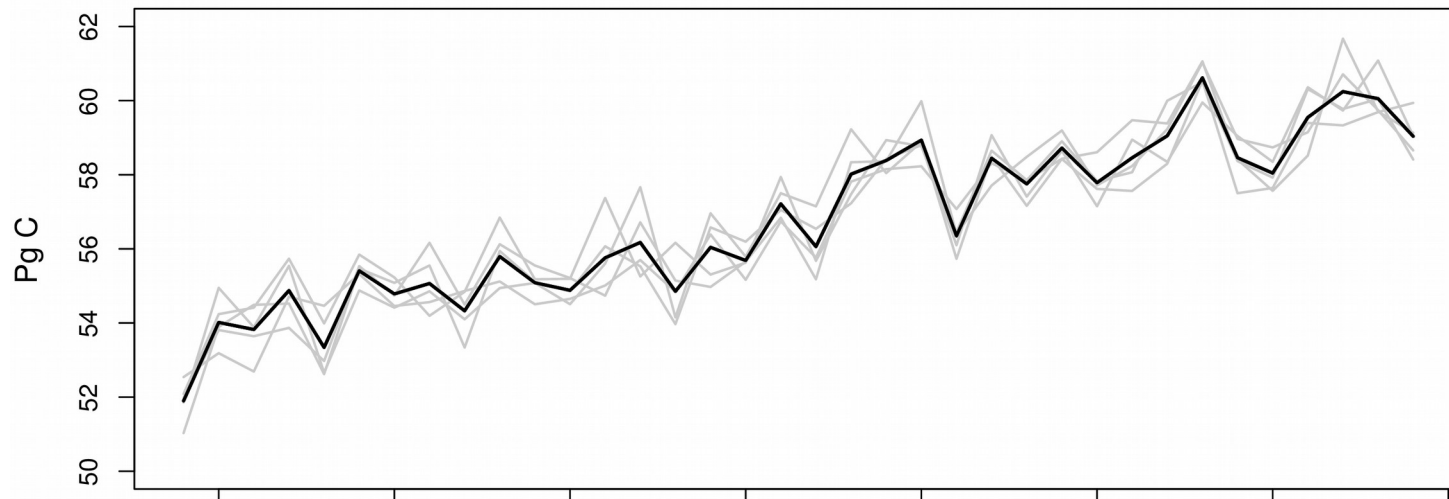

fFire - C flux due to wildfire

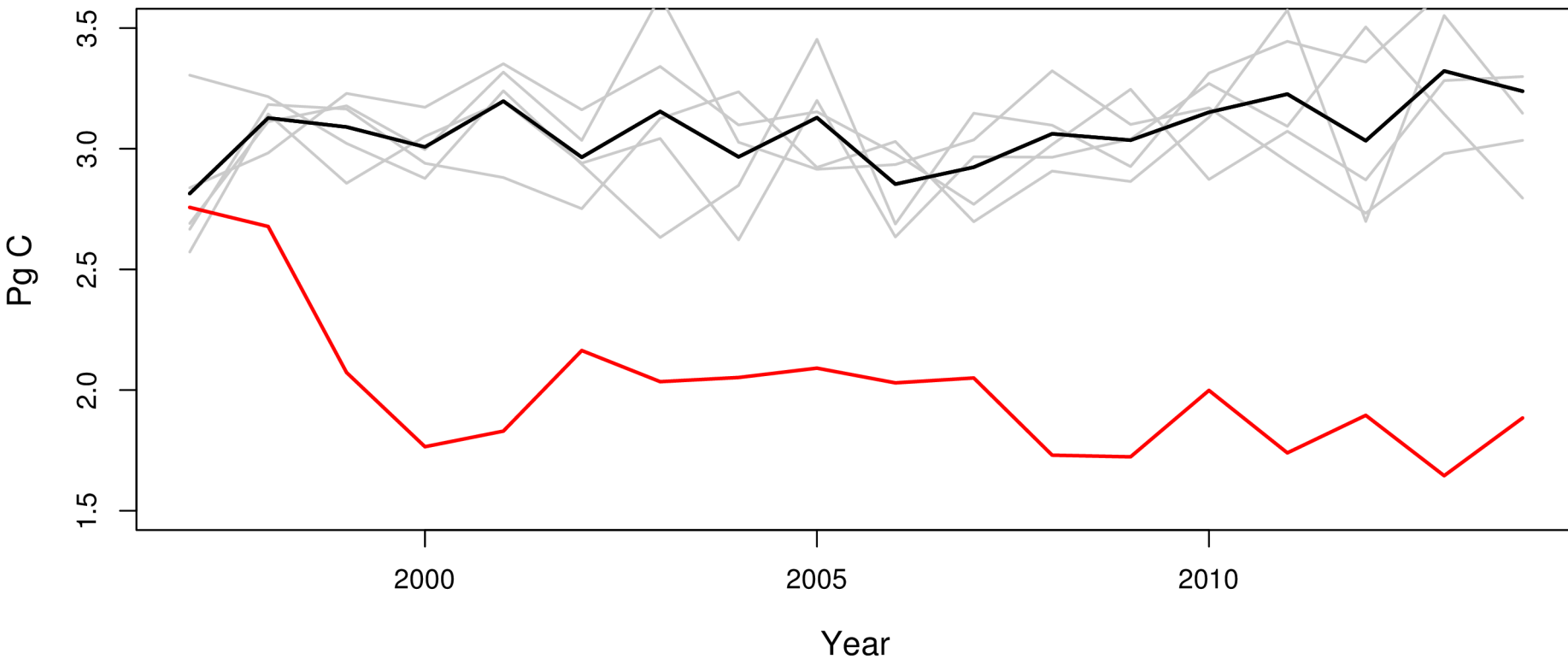

State of the art Wildfire models

Comparison of burned area simulated by several offline fire models (FIREMIP)

Current model in LPJG is the worst – GlobFIRM
The best is SIMFIRE-BLAZE – soon in our LPJG version!

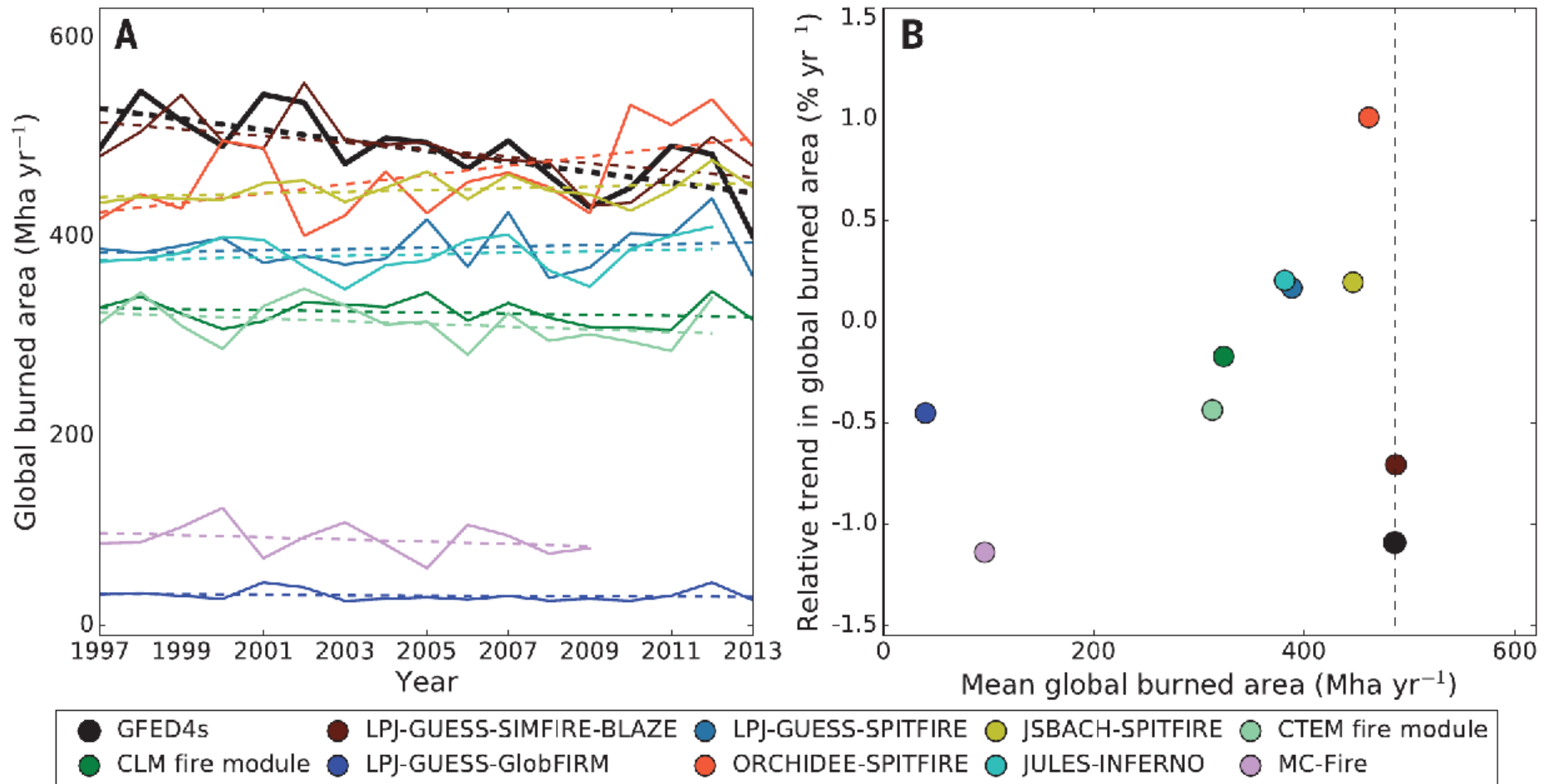

- The Future of LSM development
 - Pending merge into trunk: LPJG vendor drop for compressed output, correct bug found in OSM → LPJG
 - scientific validation & testing by others
 - Integration of LS3MIP changes into surf/offline
 - Use in CMIP6 & beyond : LS3MIP, LUMIP & DCP/CCiCC
- Future work in wildfire modeling
 - In-depth analysis of results, compared to (few) observations
 - Compare to offline runs driven by reanalyses
 - Integrate better fire models with help from partners in Lund University - SIMFIRE/BLAZE
 - Use these new models in offline decadal hindcast runs – very cheap!



**Barcelona
Supercomputing
Center**

Centro Nacional de Supercomputación



EXCELENCIA
SEVERO
OCHOA

Thank you!

etienne.tourigny@bsc.es



This project has received funding from the European Union's Horizon 2020 research and innovation programme under the Marie Skłodowska-Curie grant agreement No 748750



CCiCC



Towards a near-term prediction of the climate and carbon cycle interactions in response to Paris Agreement emission trajectories

Variability in atm CO₂ growth rate is mostly due to natural variability

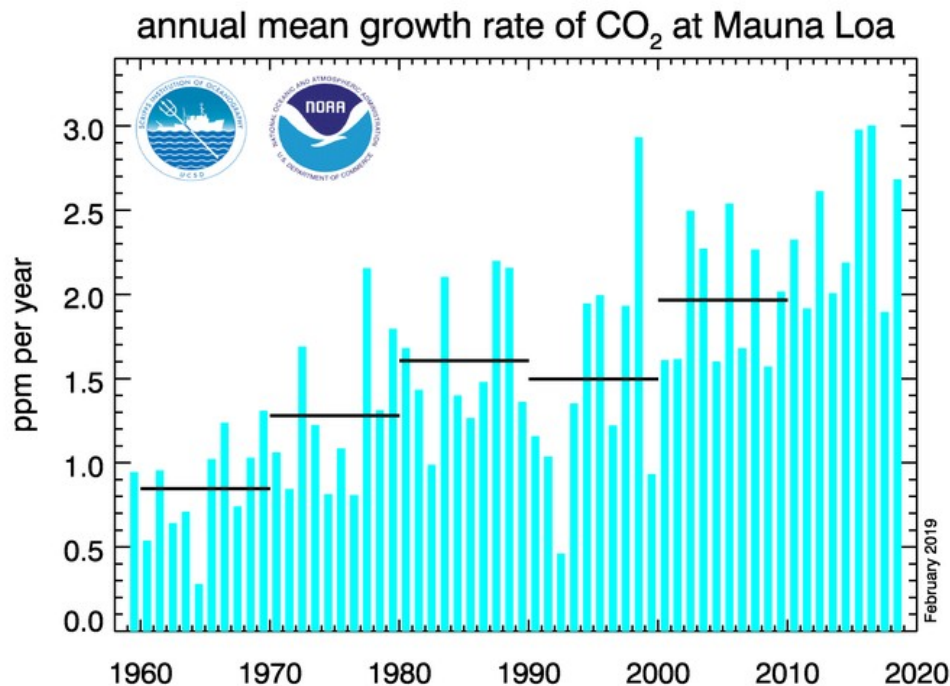

Testing different ocean biogeochemical reconstructions as initial conditions

Retrospective decadal predictions of ocean and land carbon uptake

Idealized perfect-model experiments to investigate mechanisms of C uptake predictability in the ocean.